

注：“*”□表示关键尺寸(3个).

NO.	PARTS	MATERIALS	Q'TY		TOLERANCE UNLESS SPECIFIED					
8										
7										
6					WITHIN 1.5mm : ±0.1mm	A	2012-8-13	初版		
5	SPRING	SUS	1	NATURAL	OVER 1.5mm : ±0.2mm	ISSUE	DATE	DESCRIPTIONS OF REVISION	APPD.	
4	CAM STICK	SUS	1	NATURAL	TITLE : VERTICAL PUSH SWITCH				UNIT : mm	DRWG NO.:
3	CASE	PA66/BRASS STRIP	1	GREY/Ag PLATED	MODEL:				SCALE: 5:1	
2	COVER	PA66	1	BLACK	东莞市高迪电子有限公司				DWN.	2012-8-13
1	KNOB	PA66/PBS C5210R-EH	1	WHITE/Ag CLAD					CHK'D	
								APPD.		

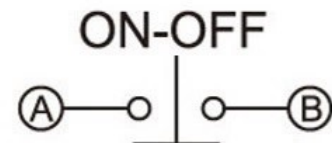
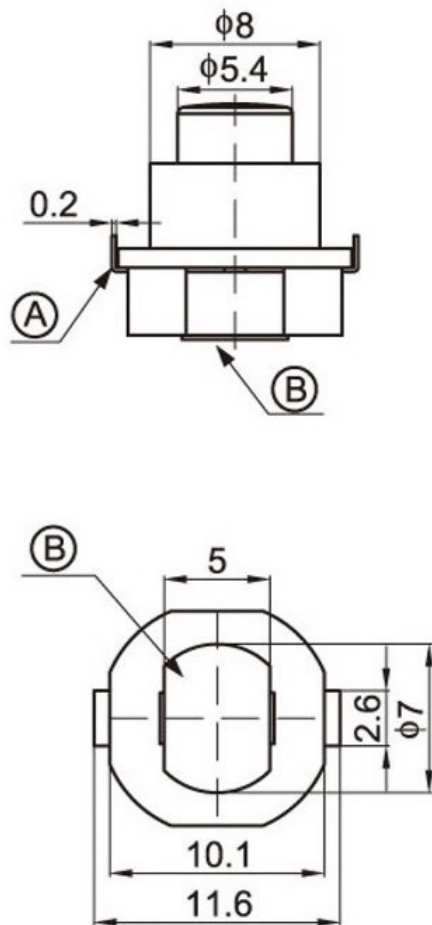
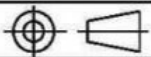

电路简图

SCHEMATIC (NON-SHORTING)

注：“*”□表示关键尺寸(3个).

				TOLERANCE					
				UNLESS SPECIFIED					
				WITHIN 1.5mm : ±0.1mm	A	2012-8-13	初版		
				OVER 1.5mm : ±0.2mm	ISSUE	DATE	DESCRIPTIONS OF REVISION		APPD.
8				TITLE : VERTICAL PUSH SWITCH		UNIT : mm	DRWG NO.:		
7				MODEL:		SCALE: 5:1	DWN.		2012-8-13
6				东莞市高迪电子有限公司			CHK'D		2012-8-13
5	SPRING	SUS	1				NATURAL	APPD.	
4	CAM STICK	SUS	1	NATURAL					
3	CASE	PA66/BRASS STRIP	1	GREY/Ag PLATED					
2	COVER	PA66	1	BLACK					
1	KNOB	PA66/PBS C5210R-EH	1	WHITE/Ag CLAD					
NO.	PARTS	MATERIALS	Q'TY						

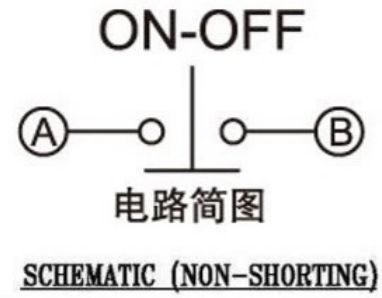
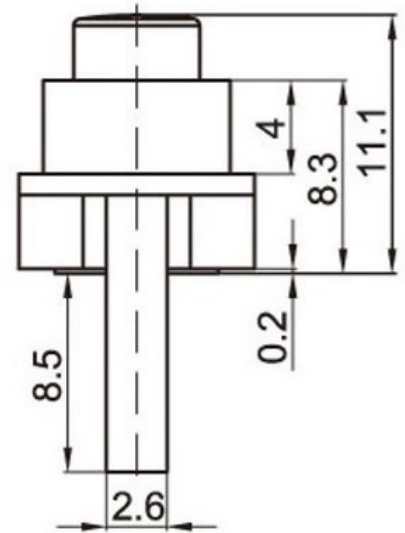
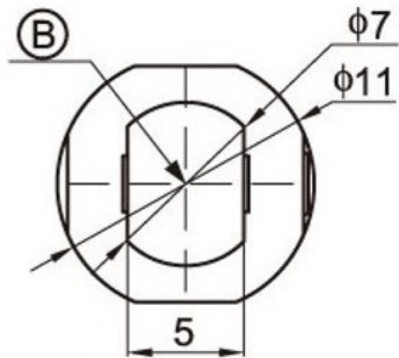
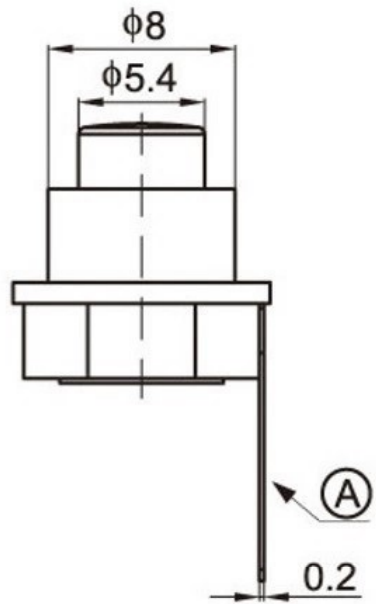
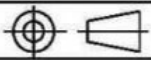

注：“*”□表示关键尺寸(3个).

NO.	PARTS	MATERIALS	Q'TY		TOLERANCE UNLESS SPECIFIED				
8									
7									
6					WITHIN 1.5mm : ±0.1mm	A	2012-8-13	初版	
5	SPRING	SUS	1	NATURAL	OVER 1.5mm : ±0.2mm	ISSUE	DATE	DESCRIPTIONS OF REVISION	APPD.
4	CAM STICK	SUS	1	NATURAL	TITLE : VERTICAL PUSH SWITCH		UNIT : mm	DRWG NO.:	
3	CASE	PA66/BRASS STRIP	1	GREY/Ag PLATED	MODEL:		SCALE: 5:1	DWN.	2012-8-13
2	COVER	PA66	1	BLACK	东莞市高迪电子有限公司			CHK'D	
1	KNOB	PA66/PBS C5210R-EH	1	WHITE/Ag CLAD				APPD.	
NO.	PARTS	MATERIALS	Q'TY						

